

Storage unit



## Description

With a contemporary design the storage unit Grant is the perfect choice for a spacious dining area. Piece by piece, the master cabinetmaker inlays and combines a large number of round ash wood dowels getting smaller and smaller; only in this way, without the industrial hectic times to be respected, the product takes shape and becomes an artwork. The central open drawer has internal partitions to contain precious sets of cutlery. A metal base with a tubular cross motif gives further elegance and refinement to this piece of furniture.

## Materials

Marble, Wooden mosaic, Metal

## Dimensions

240 W x 50 D x 81 H cm (GRANT.13400/A/MO)

240 W x 50 D x 61 H cm (GRANT.13400/B/MO)

# Grant

Storage unit



**HESSENTIA** | CORNELIO CAPPELLINI

# Grant

Storage unit



HESSENTIA | CORNELIO CAPPELLINI

# Grant

Storage unit

## GRANT.13400/A/MO

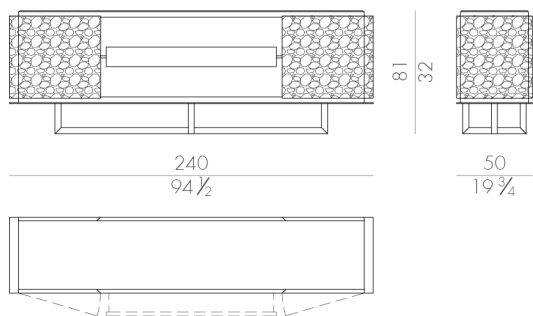

## GRANT.13400/B/MO

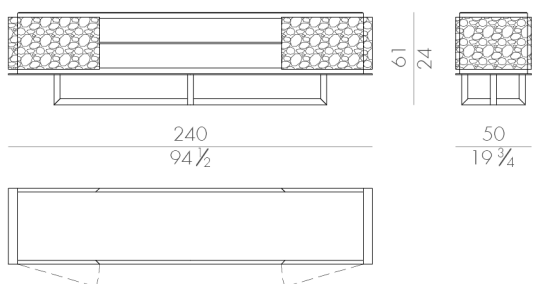

# Grant

Storage unit

## THE WORLD OF MATERIALS

---

### Wooden mosaic structure



MS11 Glossy platinum

### Lacquered internal parts



FP37 Glossy taupe



FP37M Matt taupe

### Marble top



MA13 Calacatta Oro



MA13M Matt Calacatta Oro



MA38 Arabescato Orobico

# Grant

Storage unit

## THE WORLD OF MATERIALS

---

### Metal parts

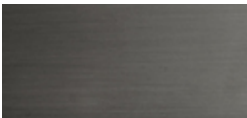

ME18 Matt black nickel finish

### Mirror back



SP31 Bronze

# Grant

Storage unit

## SUGGESTED MATCHES

---

### Wooden mosaic structure



MS11 Glossy platinum



MS11 Glossy platinum



MS11 Glossy platinum



MS11 Glossy platinum

### Lacquered internal parts



FP37 Glossy taupe



FP37 Glossy taupe



FP37 Glossy taupe



FP37M Matt taupe

### Marble top



MA38 Arabescato Orobico



MA13 Calacatta Oro



MA13M Matt Calacatta Oro



MA13M Matt Calacatta Oro

### Metal parts

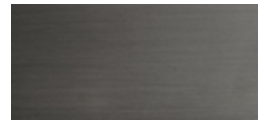

ME18 Matt black nickel finish

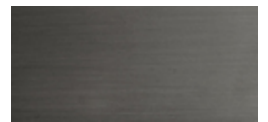

ME18 Matt black nickel finish

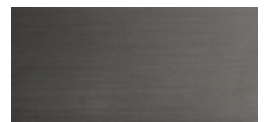

ME18 Matt black nickel finish

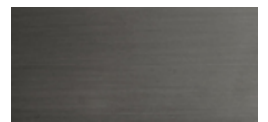

ME18 Matt black nickel finish